

Specification for approval

Customer Name _____

Customer P/N _____

Factory P/N _____

Rev. V1

Date 2021-11-22

Package Size 3.5 (L) × 2.8(W) × 0.70 (T) mm
 3.5()*2.8()*0.70()mm

Suitable for different working environment

Low power consumption and wide viewing angle

This product doesn't contain restriction Substance, comply ROHS standard
 ROHS

TV set

General lighting

Tubular light application

Flat backlight for LCD

Backlight for LCD, switch and Symbol, display
 LCD

Other illumination and displays

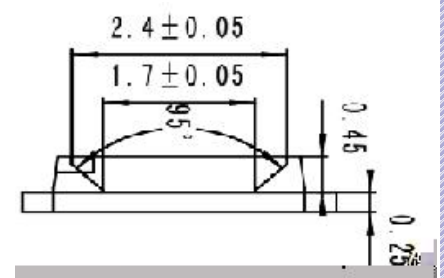
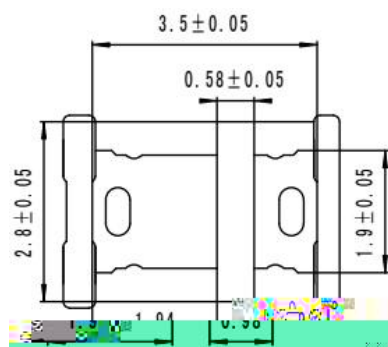
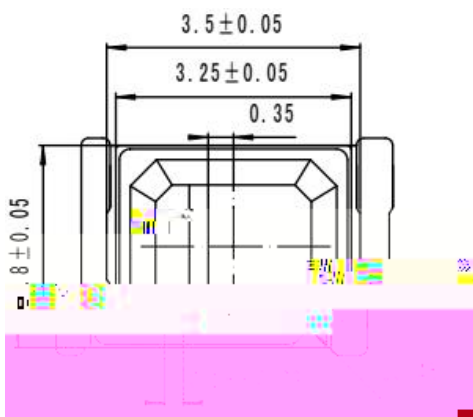
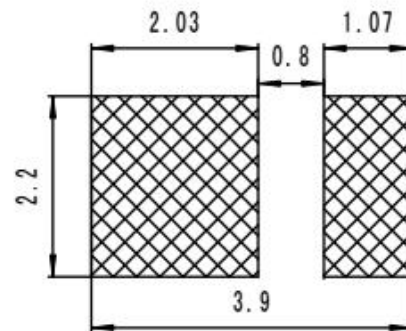

Notes

1. All dimensions are in millimeters
2. All dimensions tolerance are ±0.25mm unless otherwise noted.

Part No.	Material	Color		Luminous Flux(lm) @150mA			Viewing angle
		Emitting color	Lens color	Min	Typ	Max	2 1/2
							110°
	InGaN	Pink Purple	Light red	25	---	30	

Notes

- the above 2 1/2 measurement allowance tolerance $\pm 5^\circ$
- the above luminous flux measurement allowance tolerance $\pm 10\%$

Pulse Forward Current ()	Ifp	180	mA
Power Dissipation ()	Pd	500	mW
Reverse Voltage ()	VR	5	V
Electrostatic Discharge ()	ESD	2000	V
Operating Temperature ()	Topr	-25 +85	
Storage Temperature ()	Tstg	-40 +100	

Forward voltage	VF	IF=150mA	2.8	--	3.4	± 0.05	V
Reverse leakage current	IR	VR=5V	--	--	5	± 0.5	μA
Color Temperature	Tc	IF=150mA	--	--	--	--	k
Color rendering index	Ra	IF=150mA	--	--	--	--	/

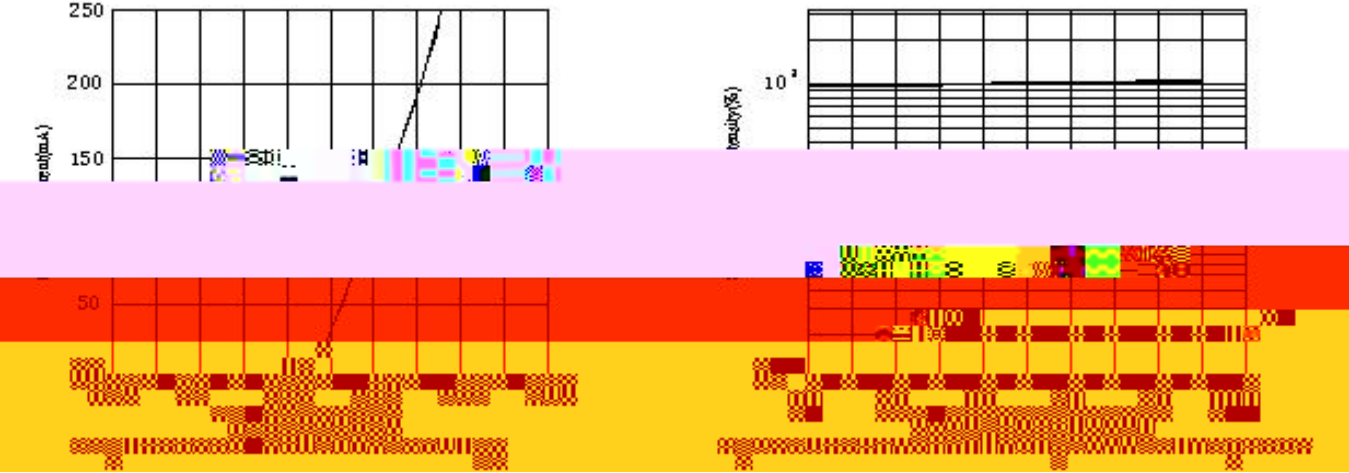

H_n 0 • € §H_n ••

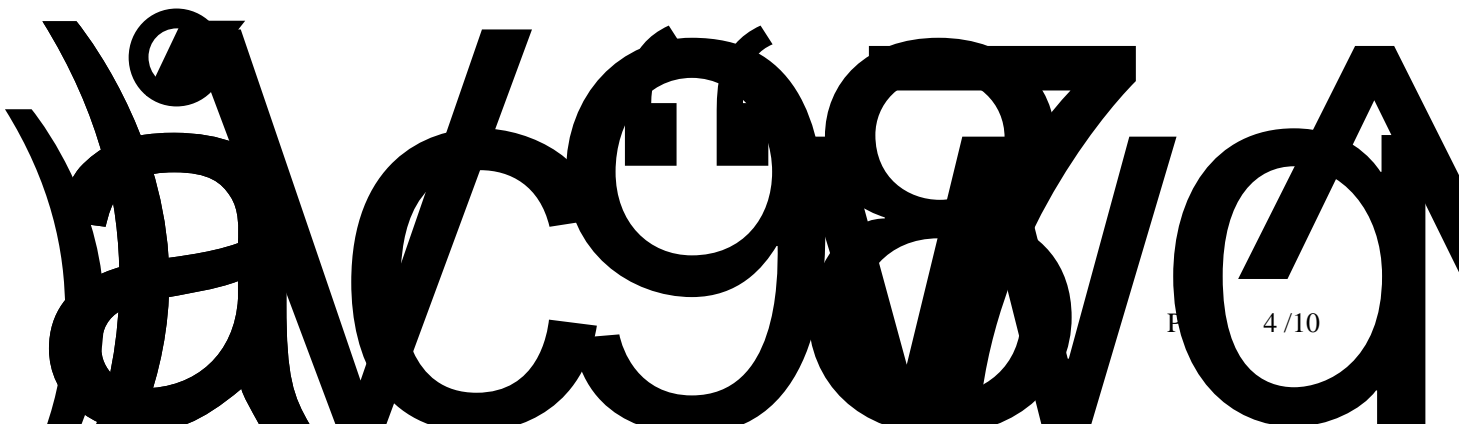

Item	Symbol	Test Conditions	Criteria for Judgement	
			Min	Max
Forward Voltage	VF	IF 150mA		U.S.L*)x1.1
Reverse Current	IR	VR=5V		U.S.L*)x2.0
Luminous Flux	LM	IF=150mA	L.S.L*)x0.7	

U.S.L: Upper standard level

L.S.L: Lower standard level

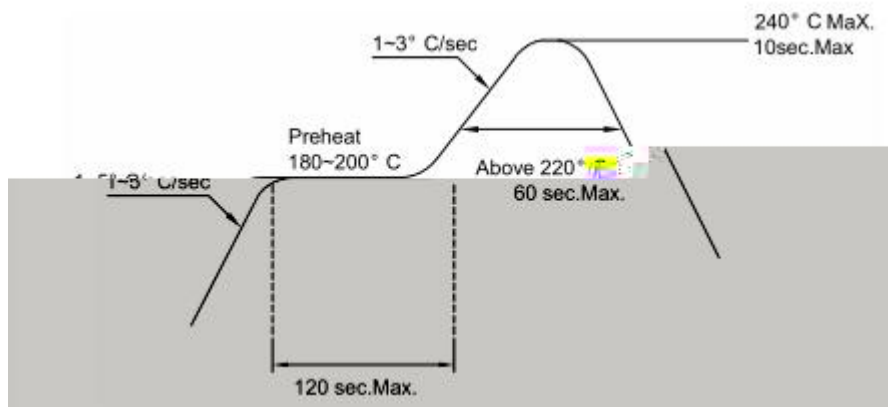

1. Reflow soldering should not be done more than two times. many times reflow soldering has destructive effect to the product

2. When soldering , do not put stress on the LEDs during heating

1. Hand Solder should not be using hand soldering iron, suggest using heating operation, the use of solder paste melting point under 220 , the heating temperature set less than or equal to 240 , the time is not more than 10 s, a welding is complete, multiple welding products are destructive
2. Handle the component along the side surface by using forceps or appropriate tools; do not directly touch or Handle the silicone lens surface, it may damage the internal circuitry.



1. The operation of Temperatures and RH are : 30 ,RH<60%.
30 ,RH<60%.
2. Once the package is opened, the products should be used within 8hours, Otherwise, more than the dehumidification process, dehumidifying conditions: reel 70 / 6 ~ 8 h, bulk LED150 / 3 h
8H
3. Considering the operation environment of temperature and humidity ,we suggest our customers to use our products within three months (from production date), More than 3 months with toasted constant temperature 70 5 for 6 ~ 8 hours desiccant (need to get rid of aluminum foil bag packing).

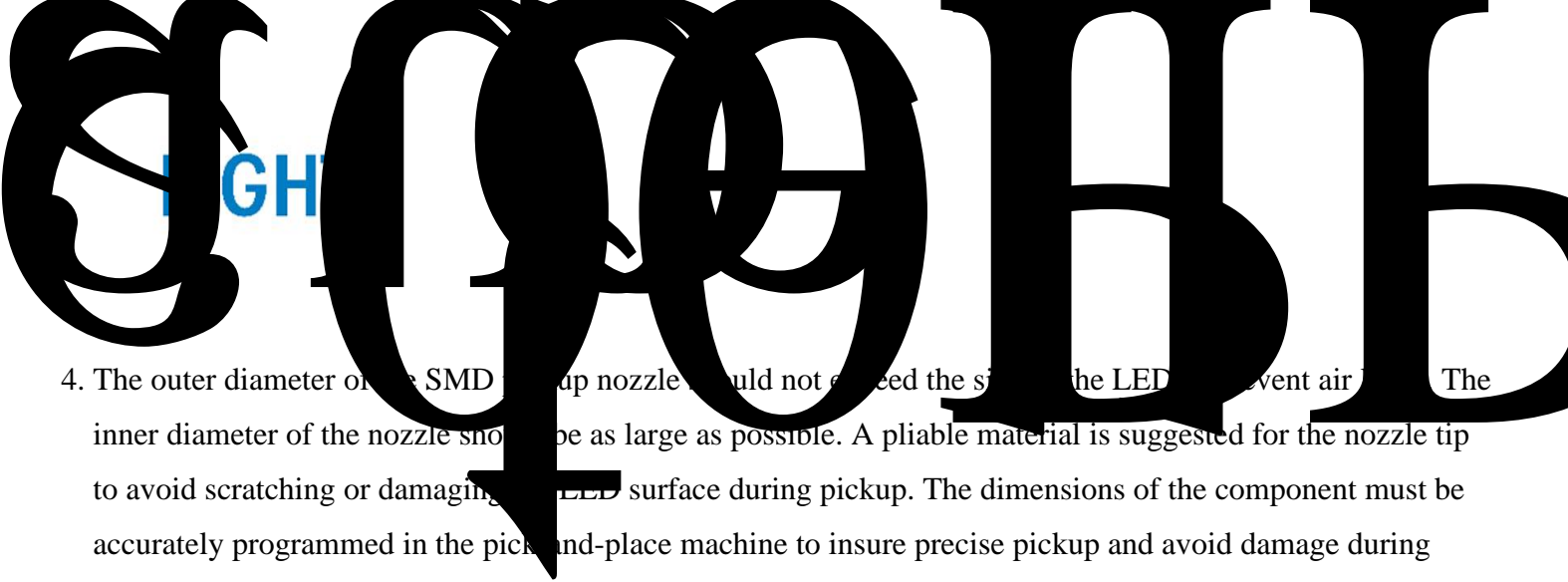

4. The outer diameter of the SMD pickup nozzle should not exceed the size of the LED. The inner diameter of the nozzle should be as large as possible. A pliable material is suggested for the nozzle tip to avoid scratching or damaging the LED surface during pickup. The dimensions of the component must be accurately programmed in the pick-and-place machine to insure precise pickup and avoid damage during production.

SMD

LED

LED

5. LED operating environment and sulfur element composition cannot be over 100PPM in the LED mating usage material.

6. When we need to use external glue for LED application products, please make sure that the external glue matches the LED packaging glue. Additionally, as most of LED packaging glue is silica gel, and it has strong Oxygen permeability as well as strong moisture permeability; in order to prevent external material from getting into the inside of LED, which may cause the malfunction of LED, the single content of Bromine element is required to be less than 900PPM, the single content of Chlorine element is required to be less than 900PPM, the total content of Bromine element and Chlorine element in the external glue of the application products

LIGHT[®]

