

SL-T0603GEC005-L40 DATA SHEET

SPEC. NO. : SZ18051006
DATE : 2018/05/10
REV. : A/0

Approved By:

Checked By:

Prepared By:

Features

- ◆ Pb free product—RoHS compliant
- ◆ Low power consumption, High efficiency
- ◆ Reliable and rugged
- ◆ Long life – solid state reliability
- ◆ Viewing Angle: 120°

Package Dimension

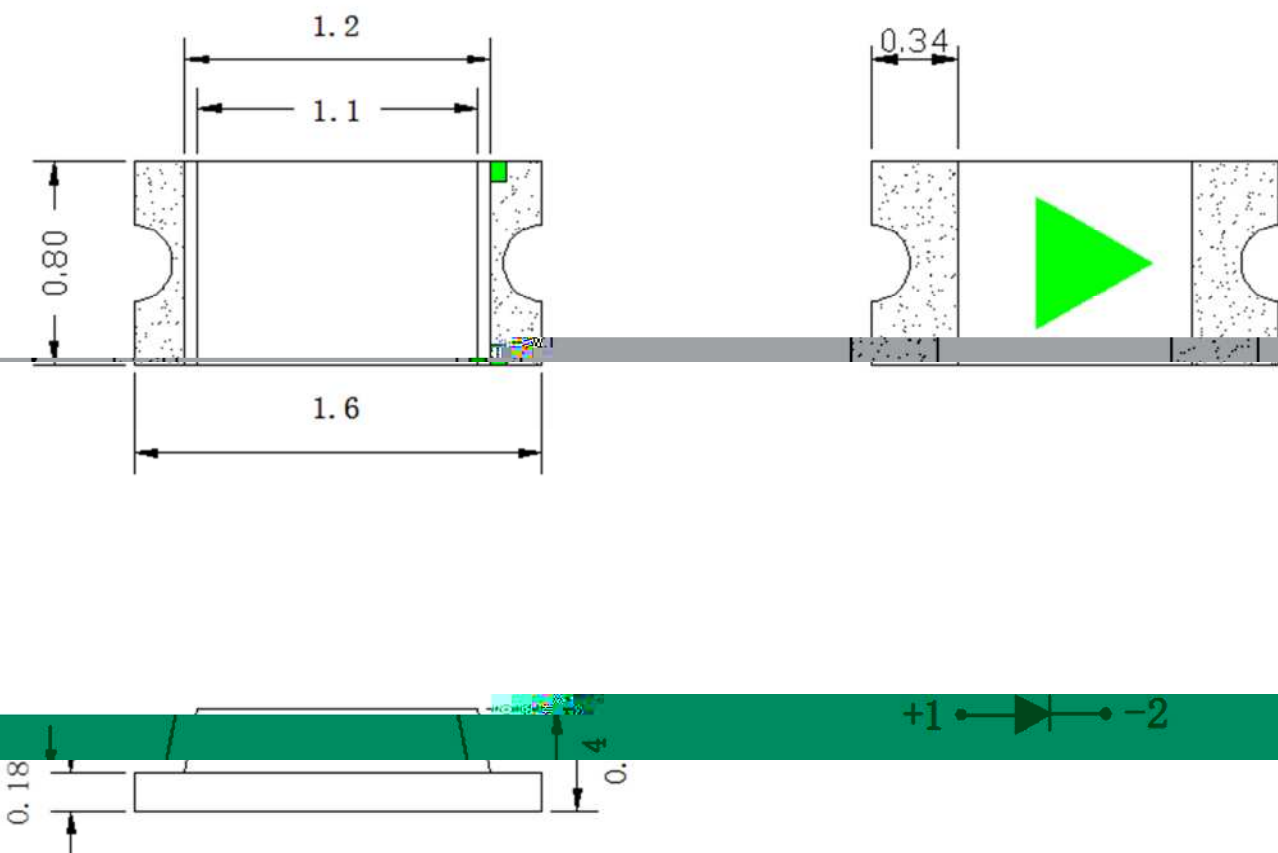

Part NO.	Lens Color	Source Color
SL-T0603GEC005-L40	Water Clear	Green

Notes:

1. All dimensions are in millimeters.
2. Tolerance is $\pm 0.10\text{mm}$ unless otherwise noted

Absolute Maximum Ratings at Ta=25

Parameter	MAX.	Unit
Power Dissipation	75	mW
Continuous Forward Current	25	mA
Peak Forward Current ^{*2}	60	mA
Reverse Voltage	5	V

Electrical Optical Characteristics at Ta=25

Parameter	Symbol	Min.	Typ.	Max.	Unit	Test Condition
Luminous Intensity	IV	200	---	400	mcd	I _F =5mA (Note 1)
Viewing Angle	2 _{1/2}	---	120	---	Deg.	(Note 2)
Dominant Wavelength	d	520	---	530	nm	I _F =5mA
Peak Emission Wavelength	p	---	515	---	nm	I _F =5mA
Spectral Line Half-Width		---	30	---	nm	---
Forward Voltage	V _F	2.4	---	3.2	V	I _F =5mA (Note 4)
Reverse Current	I _R	---	---	10	μA	V _R =5V

Note:

1. Luminous intensity is measured with a light sensor and filter combination that approximates the CIE eye-response curve. Tolerance of Luminous Intensity: ±15%.
2. _{1/2} is the off-axis angle at which the luminous intensity is half the axial luminous intensity.
3. The dominant wavelength, d is derived from the CIE chromaticity diagram and represents the single wavelength which defines the color of the device. Tolerance of Dominant Wavelength: ±1.0nm.
4. Tolerance of Forward Voltage: ±0.1V.

LIGHT

Label Explanation

LIGHT

RoHS



Reel Dimensions

Note: Tolerance unless mentioned is $\pm 0.2\text{mm}$; Unit = mm

Carrier Tape Specifications (Loaded Quantity: 4000pcs/reel)

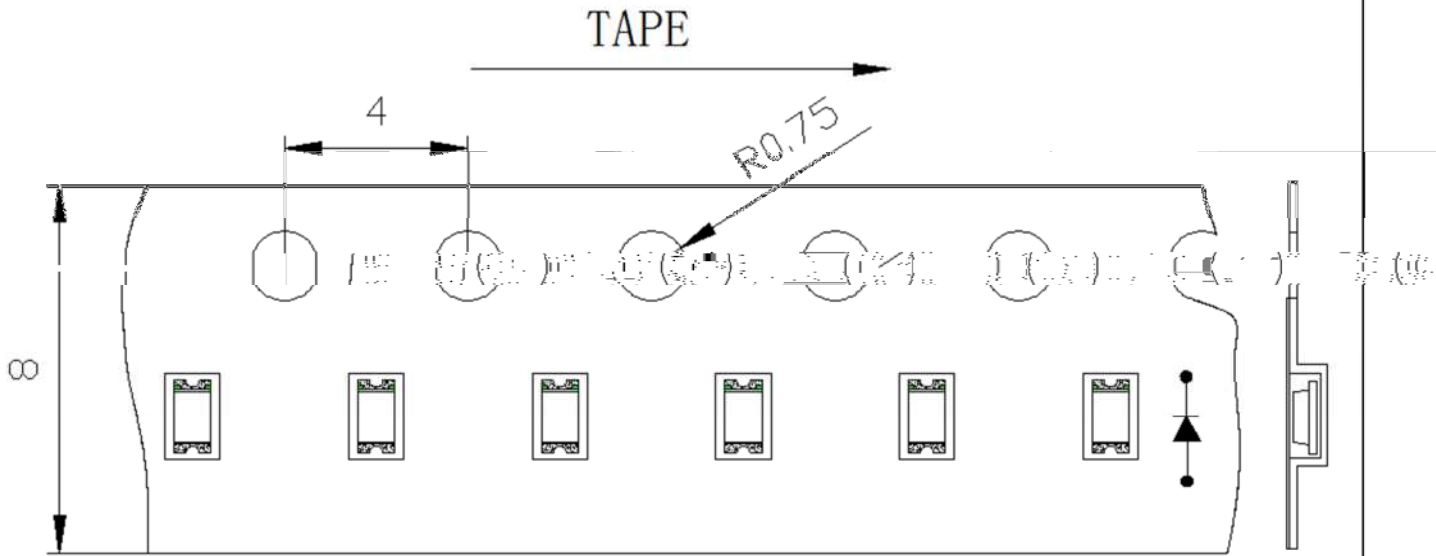

Moisture Resistant Packaging

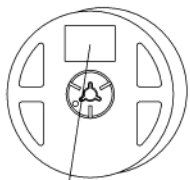

LIGHT universal Label

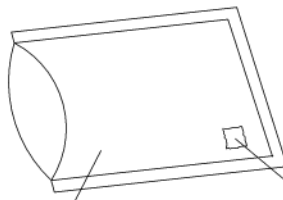
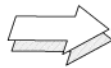

Aluminum moisture-proof bag

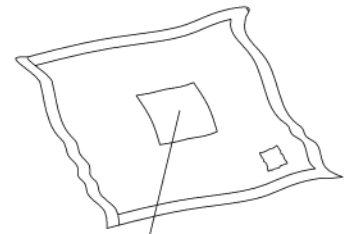
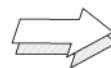

Customer defined Label or LIGHT universal Label

Suggest IR Reflow Condition For Lead Free

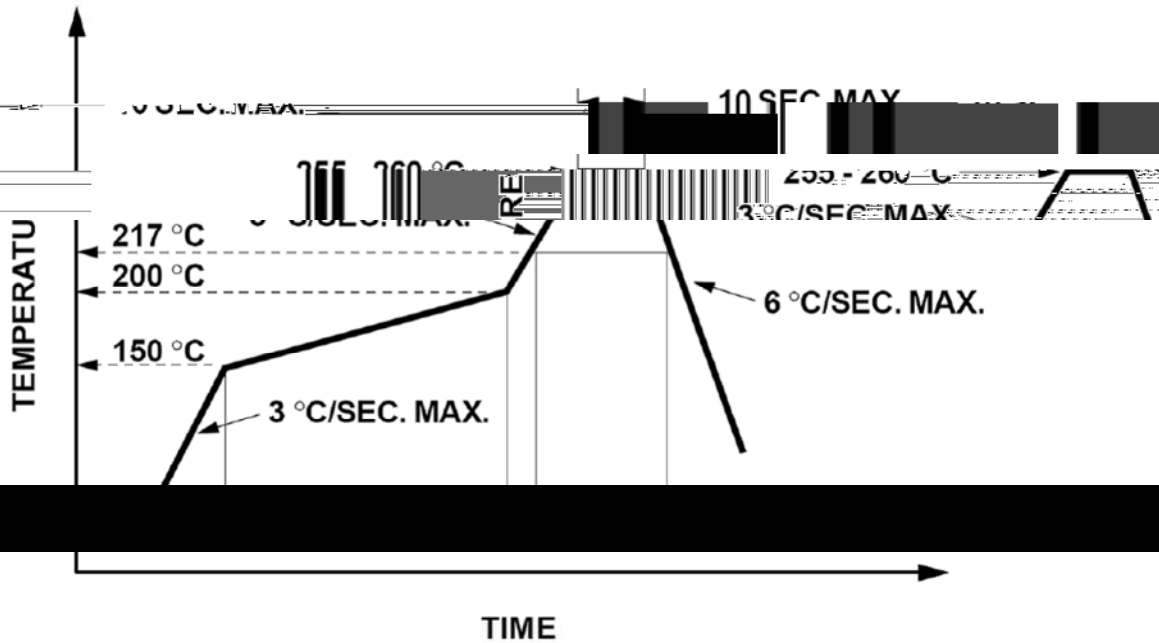

1. Reflow soldering should not be done more than two times.
2. When soldering, do not put stress on the LEDs during heating.

Soldering iron

1. When hand soldering, the temperature of the iron must less than 300°C for 3 seconds.
2. The hand solder should be done only once.

Repairing

Repair should not be done after the LEDs have been soldered. When repairing is unavoidable, a double-head soldering iron should be used (as below figure). It should be confirmed beforehand whether the characteristics of LEDs will or will not be damaged by repairing.

