

# **SL-T3020IRC050-L236-C-S**

\_\_\_\_\_  
\_\_\_\_\_  
\_\_\_\_\_



## Absolute Maximum Ratings at Ta=25

**1. Storage and operating:**

## Electrical Optical Characteristics at Ta=25

	2					
Peak Wavelength	p	---	940	---	nm	I
		---	50	---	nm	I

Note:

2

## Typical Electrical / Optical Characteristics Curves (25 Ambient Temperature Unless Otherwise Noted)

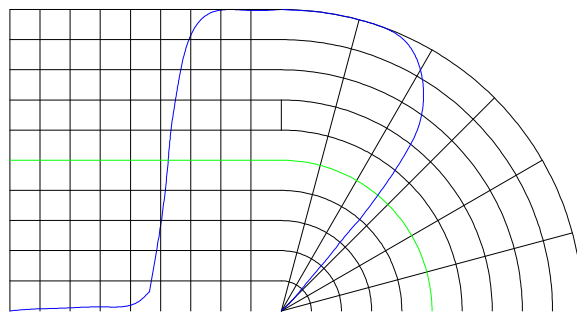
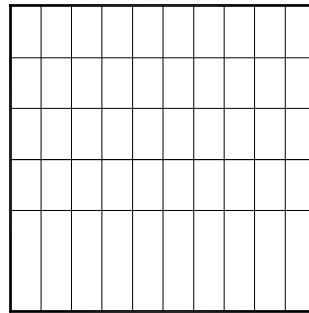
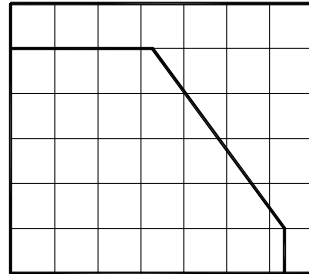
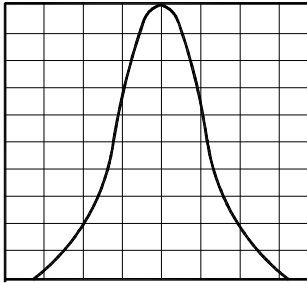

# LIGHT

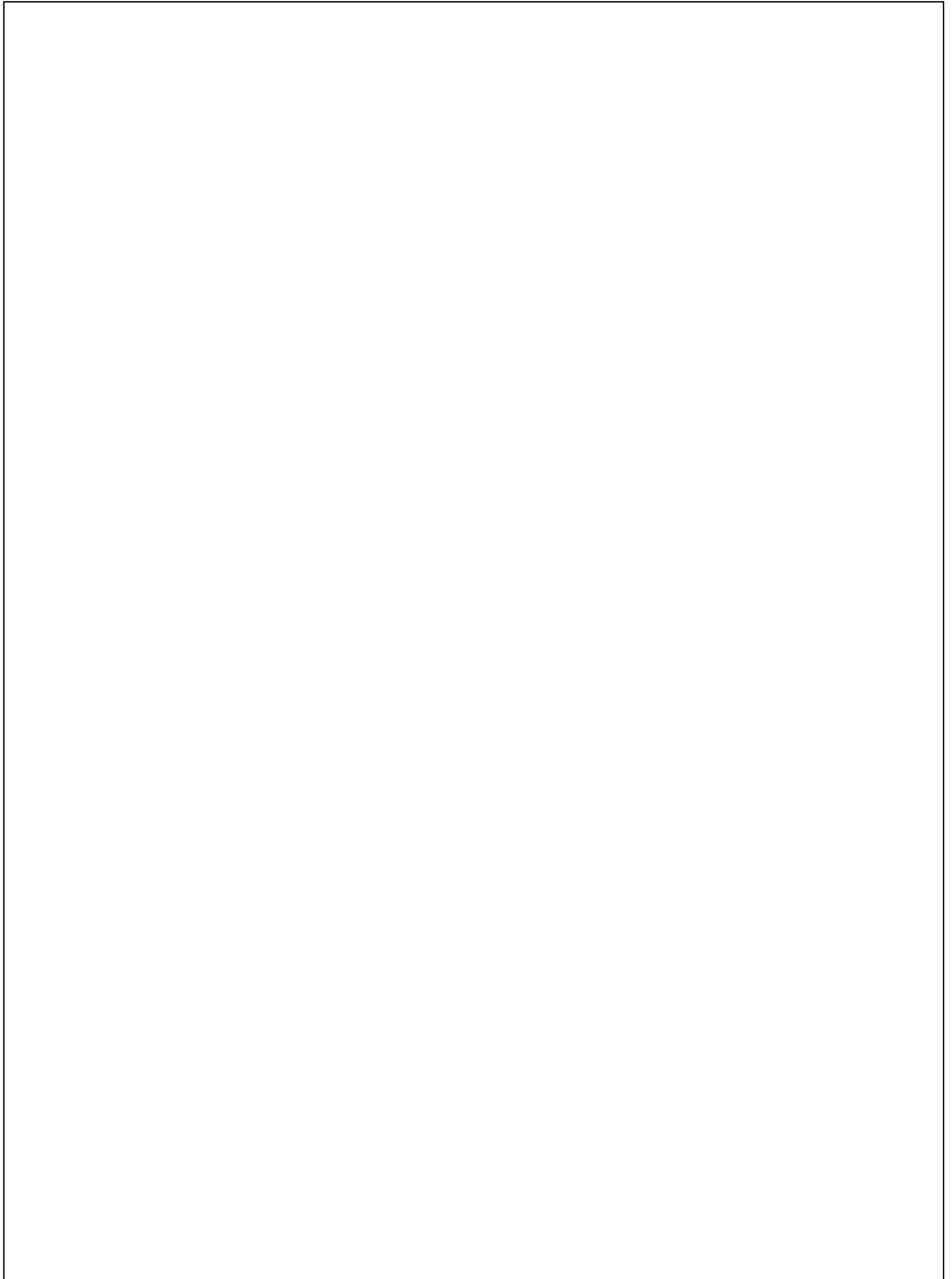

**LIGHT**  
Light Electronics CO., LTD

MODEL NAME: \_\_\_\_\_

QUANTITY: \_\_\_\_\_

BIN: \_\_\_\_\_

PACKING DATE: \_\_\_\_\_

REMARKS: \_\_\_\_\_

LOT NO. : \_\_\_\_\_



**LIGHT**  
Light Electronics CO., LTD

MODEL NAME: \_\_\_\_\_



QUANTITY: \_\_\_\_\_

BIN: \_\_\_\_\_

PACKING DATE: \_\_\_\_\_

CUSTOMER P/N: \_\_\_\_\_

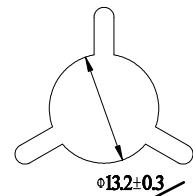
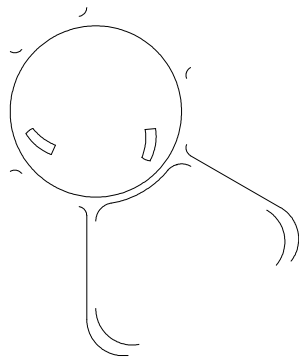
LOT NO. : \_\_\_\_\_



LIG

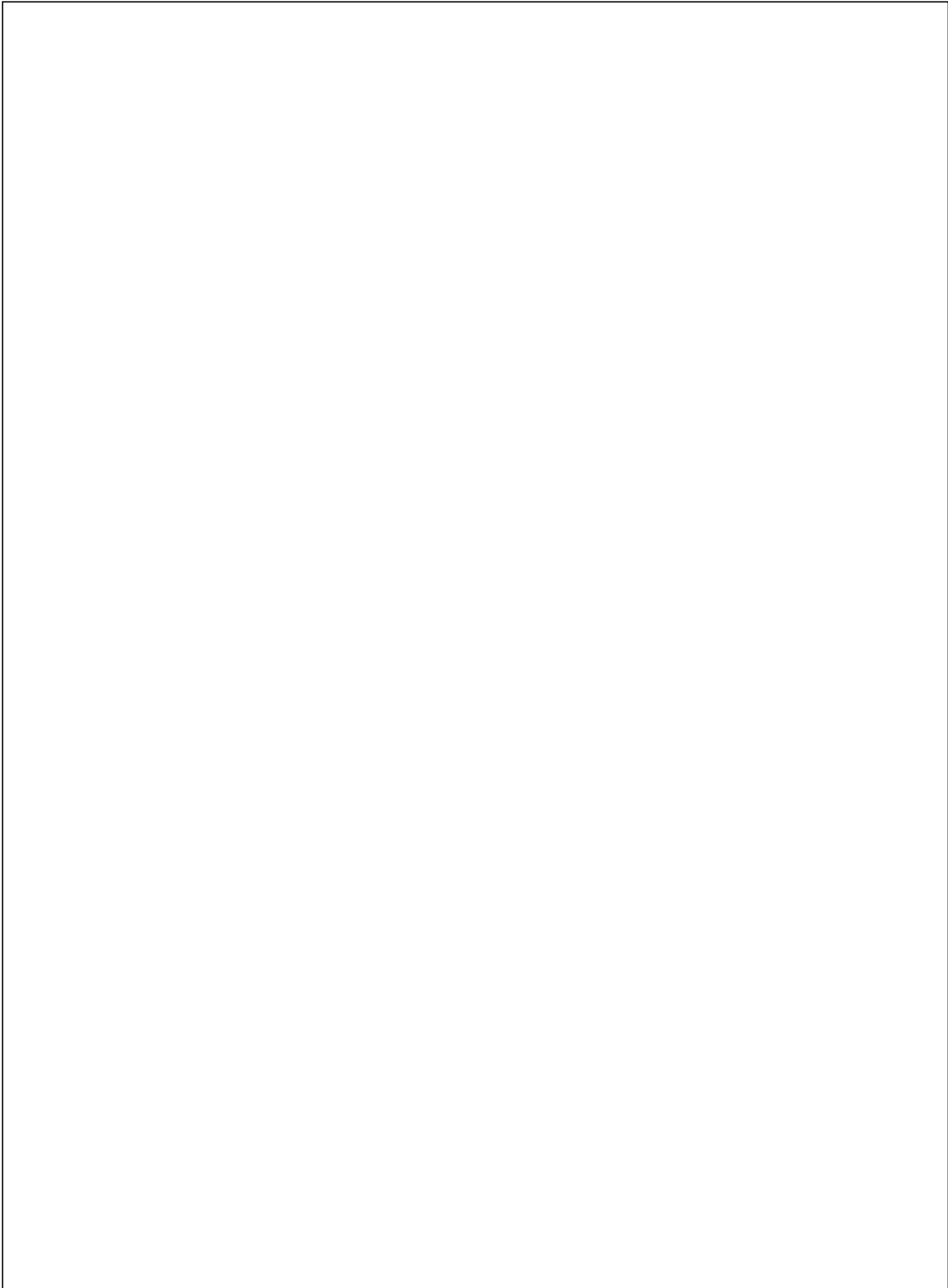



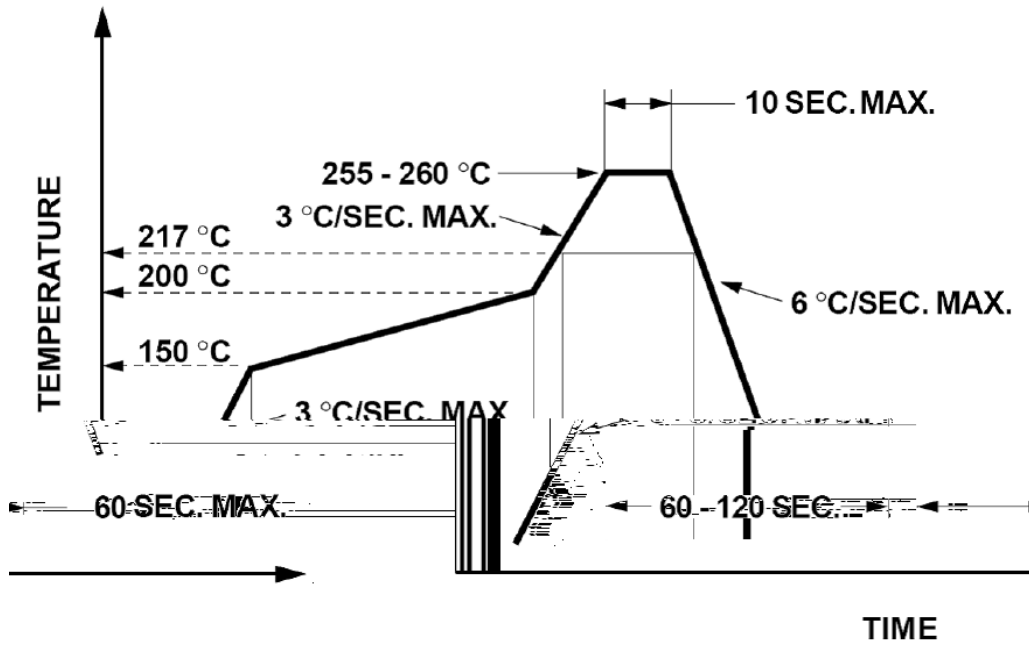

°C

